











33 525 660



- Ausladung 105 mm
- starrer Auslauf
- runder luftangereicherter Strahl
- Armaturenhöhe 138 mm
- Höhe bis Luftsprudler 57 mm
- Bohrungsdurchmesser 35 mm
- Rosette Ø 50 mm wahlweise
- 2x Druckschlauch M 8 x 1 eingeschraubt, dichtheitsgeprüft
- Durchfluss max. 5,7 l/min
- bleifrei
- Dieses Produkt leistet einen Beitrag zur Erfüllung der Vorgaben von nachhaltigen Gebäudezertifizierungen, z.B. LEED®, BREEAM®, DGNB

|   |                                 |               |
|---|---------------------------------|---------------|
|    | Platin                          | 33 525 660-08 |
|    | Chrom                           | 33 525 660-00 |
|    | Platin gebürstet                | 33 525 660-06 |
|    | Dark Chrome                     | 33 525 660-19 |
|    | Light Gold                      | 33 525 660-26 |
|    | Light Gold gebürstet            | 33 525 660-27 |
|    | Messing gebürstet (23kt Gold)   | 33 525 660-28 |
|    | Rot                             | 33 525 660-29 |
|    | Orange                          | 33 525 660-30 |
|   | Dunkelgrün                      | 33 525 660-31 |
|  | Schwarz matt                    | 33 525 660-33 |
|  | Bronze gebürstet                | 33 525 660-42 |
|  | Champagne gebürstet (22kt Gold) | 33 525 660-46 |
|  | Champagne (22kt Gold)           | 33 525 660-47 |
|  | Chrom gebürstet                 | 33 525 660-93 |
|  | Dark Platin gebürstet           | 33 525 660-99 |

33 525 660

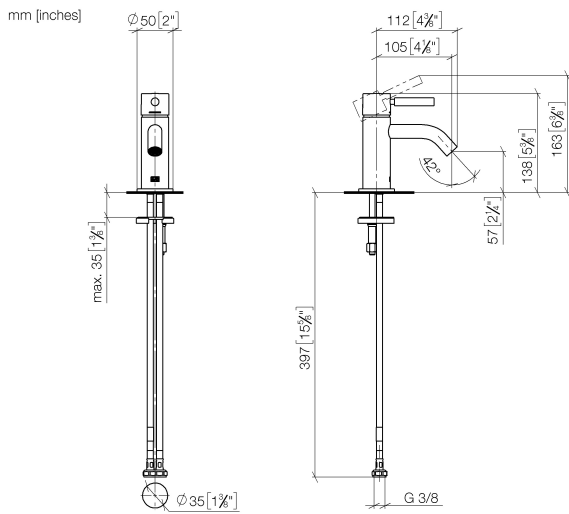

**Durchflussdiagramm**



**Zertifikate**

LGA\_29690.

DVGW\_DW-  
6506DN0128.

WRAS\_2003058.

33 525 660

Ersatzteile für die  
anderen  
Oberflächenvarianten  
finden Sie hier:  
Chrom

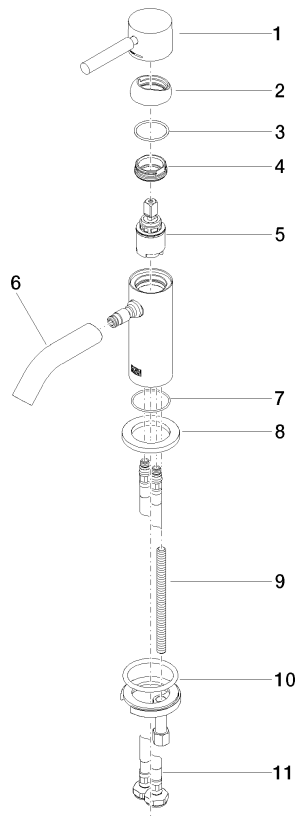

**Ersatzteilstückliste**

| Nr. | Artikelnummer      | Benennung        | Verbaumenge | Lieferzeit |
|-----|--------------------|------------------|-------------|------------|
| 1   | 90 20 66 009 00-08 | Griff            | 1           | 40         |
| 2   | 09 28 30 043-08    | Haube            | 1           | 40         |
| 3   | 09 14 10 120 90    | Dichtung         | 1           | 2          |
| 4   | 09 24 04 266 90    | Mutter           | 1           | 2          |
| 5   | 90 15 05 044 00 90 | Kartusche        | 1           | 2          |
| 6   | 90 11 06 212 00-08 | Auslauf          | 1           | 40         |
| 7   | 09 14 10 202 90    | Dichtung         | 1           | 2          |
| 8   | 09 27 66 006-08    | Rosette          | 1           | 40         |
| 9   | 09 31 11 012 90    | Stift            | 1           | 2          |
| 10  | 04 30 11 038 00 90 | Befestigungssatz | 1           | 2          |
| 11  | 04 30 04 100 00 90 | Schlauch         | 2           | 2          |